

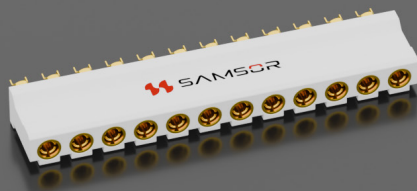

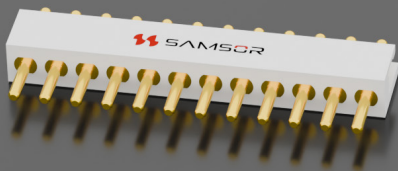

JL27 Series

PCB Connector

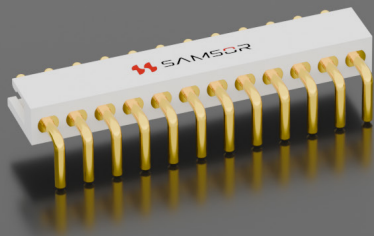

Product Selection Guide

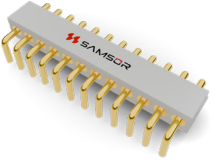
JL27 Standard Series		
		
2 Pre-wired Plug	3 Pre-wired Plug(Double-Ended Cable)	4 Solder Cup Plug
		
5 Vertical PCB Receptacle	6 Right Angle PCB Receptacle	

Features

Corresponding to the National Military Standard GJB 1438A-2006
Number of Contacts: Available in 19 configurations with 2, 3, 4, 5, 6, 7, 8, 9, 10……18, 19 and 20 pins
Adopts a multi-lamella spring socket structure, with 3.96mm standard spacing, arranged in a single row
Conductor cross-sectional area suitable for 0.75mm ² to 1.5mm ² . For thinner wires, modification is required; please specify when ordering. Default supply: 1.0mm ² white high-temperature silver-plated wrapped wire

Performance Specifications

Operating Temperature: -65°C~ +125°C	Dielectric Withstand Voltage: 1500V (AC)
Rated Voltage: 250V AC	Durability: 500 times
Rated Current: 13A	Vibration: 10Hz-2000Hz acceleration 147m/s ² Interruption duration ≤ 1μs
Insulation Resistance: ≥ 5000MΩ (at normal condition)	Shock: 980m/s ² Interruption duration ≤ 1μs

How to order

JL27 - × ZJ/TK × - S (Note)

Series: JL27

Contact Layout: 2、3、4、5、6、7、8、9、10……18、19、20

Contact Type: ZJ - Receptacle with Pin TK - Plug with Socket

Termination Type:

B - Vertical PCB W - Right angle PCB
 Y - Pre-wired H - Solder Cup

Cable Type: S - Double-ended Cable Omit - Single-ended Cable

Note: Wire Requirements for Pre-wired Product

If not specified, the default configuration is L=200 mm, AFR250 - 1.0mm²-250V, Colored wire (Brown Black Red Blue White Five Colors Repeat)

If there are other requirements, specify as follows: Wire length (from the rear exit point, unit: mm, default: 200mm); Braid shield (P - Lightweight braided shield; default: no braid shield); Nylon sleeve (F - for military green nylon sleeve; Default: No nylon sleeve); Wire Grade (commonly AFR250, default AFR250); Wire Gauge (compatible with 0.75mm² - 1.5mm², default: 1.0mm²); Wire Color (optional multiple colors, default: Colored wire), Default items may be omitted; all other requirements can be noted. The above notes do not appear on product markings. They only serve as wire requirements for ordering pre-wired products with leads. For additional wiring definitions or requirements, please contact our engineers.

Note Examples:

(L600PF AFR250 1.0) - Length: 600mm, (Brown Black Red Blue White Five Colors Repeat), type AFR250, Gauge: 1.0mm², braided shielding over wire; nylon sleeve over shielding

(L300F 0.75 White) - Length: 300mm, white wire, type AFR250, Gauge: 0.75mm², without braid shield, with nylon sleeve over the wire

Pre-wired Plug

JL27	-	12	TK	Y	-	L	(Note)
------	---	----	----	---	---	---	--------

Series: JL27

Contact Layout: 2、3、4、5、6、7、8、9、10……18、19、20

Contact Type: TK - Plug with Socket

Termination Type: Y - Pre-wired

Wire Length: Default wire length is L = 200 mm

Note: For wire configuration, please refer to the notes in the "Model Naming" section

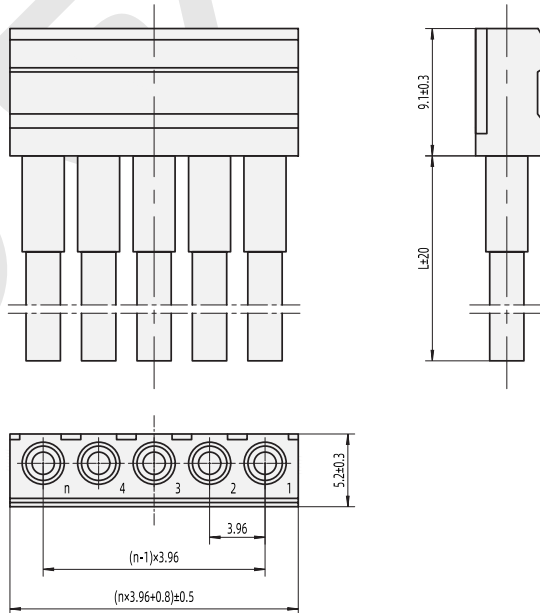
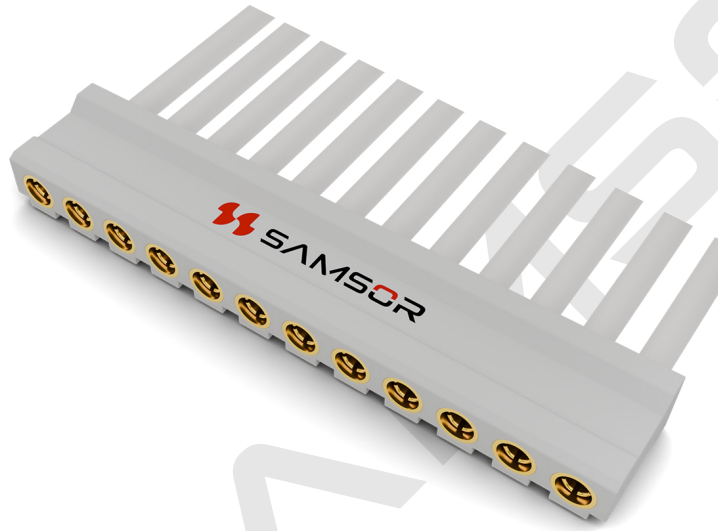

Note

Product dimensions depend on the number of contacts (n)

Pre-wired Plug

JL27	-	12	TK	Y	-S	-	L	(Note)
------	---	----	----	---	----	---	---	--------

Series: JL27

Contact Layout: 2、3、4、5、6、7、8、9、10……18、19、20

Contact Type: TK - Plug with Socket

Termination Type: Y - Pre-wired

Cable Type: S - Double-ended Cable

Wire Length: Default wire length is L = 200 mm

Note: For wire configuration, please refer to the notes in the "Model Naming" section

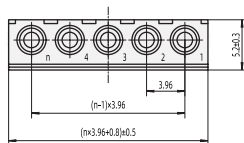
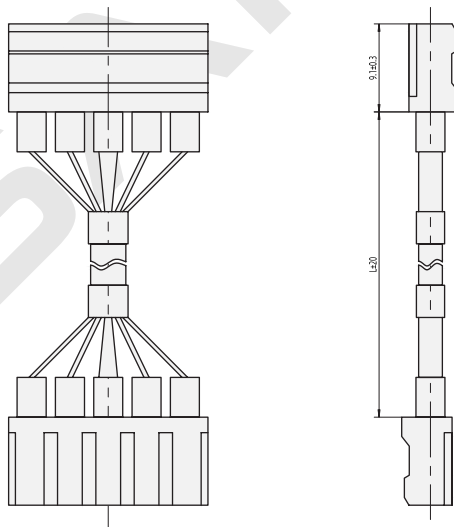
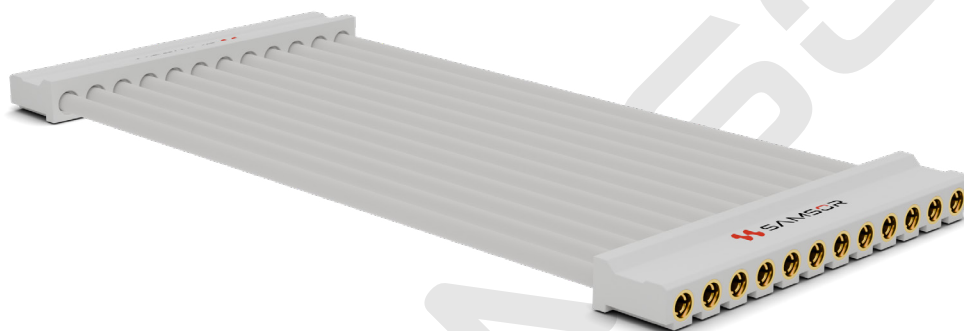

Note

Product dimensions depend on the number of contacts (n)

Solder Cup Plug

JL27	-	12	TK	H
------	---	----	----	---

Series: JL27

Contact Layout: 2, 3, 4, 5, 6, 7, 8, 9, 10.....18, 19, 20

Contact Type: TK - Plug with Socket

Termination Type: H - Solder Cup

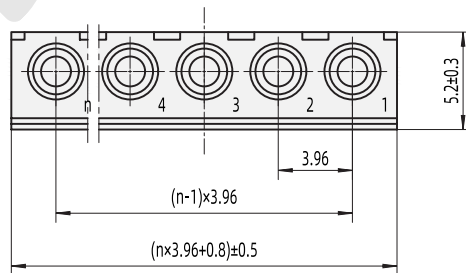
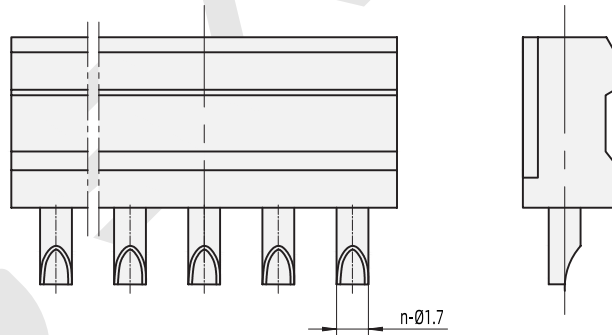
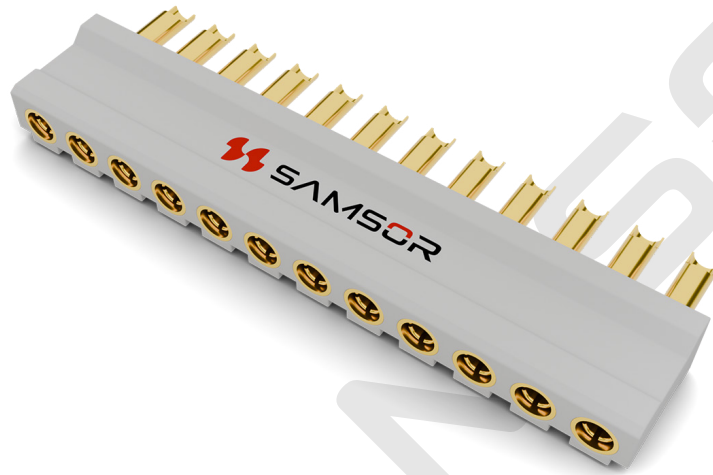

Note

Product dimensions depend on the number of contacts (n)

PCB Receptacle-Vertical

JL27	-	12	ZJ	B	-	XX
------	---	----	----	---	---	----

Series: JL27

Contact Layout: 2, 3, 4, 5, 6, 7, 8, 9, 10……18, 19, 20

Contact Type: ZJ - Receptacle with Pin

Termination Type: B - Vertical PCB

Pin Length: No marking: Default length is 3.6mm -2: Default length is 8mm -3: Default length is 5.5mm

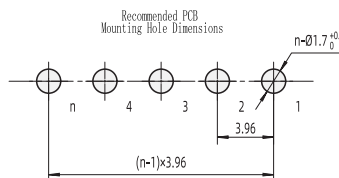
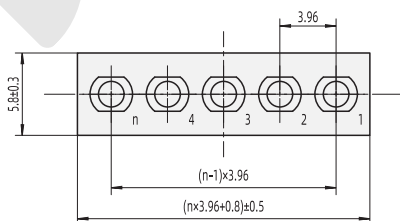
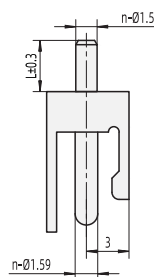
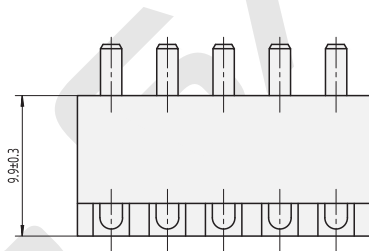
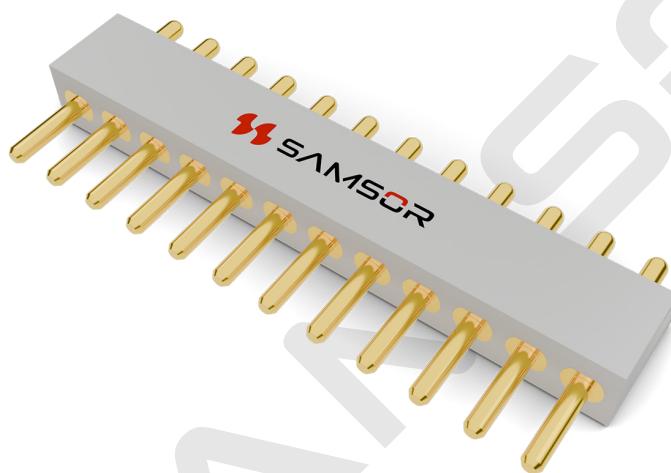

- JL27-ZJB: Standard type, L=3.6mm
- JL27-ZJB-2: Extended pin type, L=8mm
- JL27-ZJB-3: Extended pin type, L=5.5mm

Note

Product dimensions depend on the number of contacts (n)

PCB Receptacle-Right Angle

JL27	-	12	ZJ	W	-	XX
------	---	----	----	---	---	----

Series: JL27

Contact Layout: 2、3、4、5、6、7、8、9、10……18、19、20

Contact Type: ZJ - Receptacle with Pin

Termination Type: W - Right angle PCB

Pin Length: No marking: Default length is 3.6mm -2: Default length is 8mm -3: Default length is 5.5mm

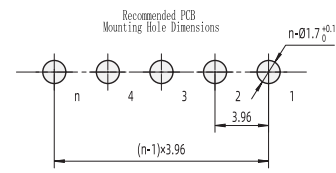
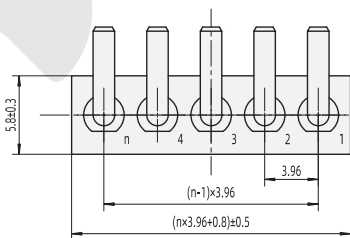
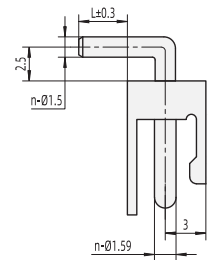
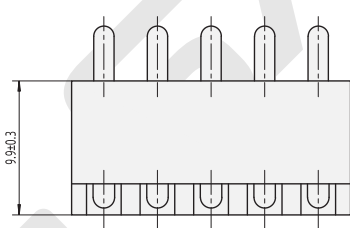
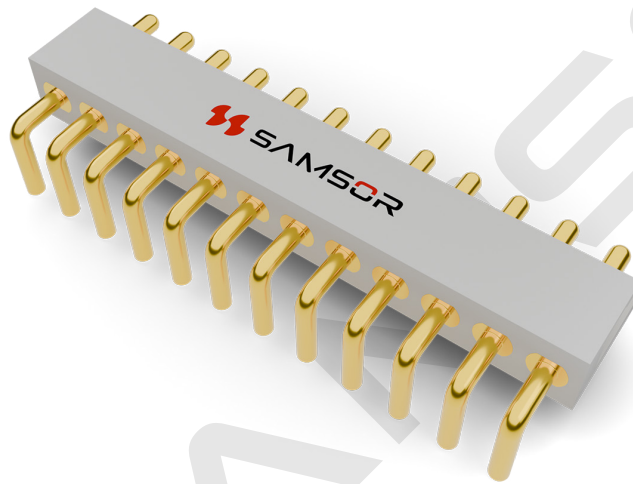

- JL27-ZJW: Standard type, L=3.6mm
- JL27-ZJW-2: Extended pin type, L=8mm
- JL27-ZJW-3: Extended pin type, L=5.5mm

Note

Product dimensions depend on the number of contacts (n)

Note

- The through-hole diameter for the solder pin mounting shall be greater than 0.8 mm (or 31 mil as specified), otherwise the solder pin may not pass through the PCB
- The solder pin length (L) shall be selected according to the PCB thickness (H). To ensure soldering quality, it is recommended that $L - H \geq 1$ mm
- During soldering, the insulator must be flush with the PCB surface. Tilting or suspending the insulator is strictly prohibited
- For manual soldering, a solder temperature of $(260 \pm 10)^{\circ}\text{C}$ is recommended, with soldering time not exceeding 5 seconds. When using a constant-temperature soldering iron at $(350 \pm 10)^{\circ}\text{C}$, the soldering time should be (2~3) seconds